

## Panel feed-through terminal block - UWV 25/S - 3073458

Please be informed that the data shown in this PDF Document is generated from our Online Catalog. Please find the complete data in the user's documentation. Our General Terms of Use for Downloads are valid (<http://phoenixcontact.com/download>)

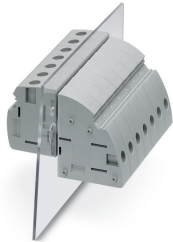

Panel feed-through terminal block, connection method: Screw connection with tension sleeve, Screw connection with tension sleeve, number of positions: 1, load current: 101 A, cross section: 6 mm<sup>2</sup> - 35 mm<sup>2</sup>, connection direction of the conductor to plug-in direction: -90 °, width: 15.1 mm, color: gray

### Your advantages

- ✓ Well-known connection principle allows worldwide use
- ✓ Low temperature rise, thanks to maximum contact force
- ✓ Tool-free snap-in principle enables easy mounting on the device panel
- ✓ Automatic panel thickness compensation enables universal use

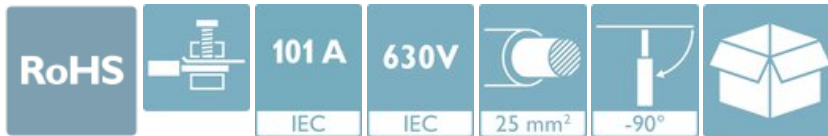

### Key Commercial Data

Packing unit	1 pc
Minimum order quantity	25 pc
GTIN	 4 046356 344753
GTIN	4046356344753
Weight per Piece (excluding packing)	62.400 g
Custom tariff number	85369010
Country of origin	China

### Technical data

#### Item properties

Brief article description	Panel feed-through terminal block
Range of articles	UWV 25
Pitch	15.1 mm
Number of positions	1

# Panel feed-through terminal block - UWV 25/S - 3073458

## Technical data

### Item properties

Number of connections	2
Number of potentials	1

### Electrical parameters

Nominal current	101 A
Nom. voltage	630 V
Maximum load current	125 A (with 35 mm <sup>2</sup> conductor cross section)
Rated voltage (III/3)	630 V
Rated surge voltage (III/3)	6 kV

### Connection capacity, external

Connection method	Screw connection with tension sleeve
Connection direction of the conductor to plug-in direction	-90 °
Conductor cross section solid	6 mm <sup>2</sup> ... 35 mm <sup>2</sup>
Conductor cross section flexible	10 mm <sup>2</sup> ... 25 mm <sup>2</sup>
Conductor cross section flexible, with ferrule without plastic sleeve	4 mm <sup>2</sup> ... 25 mm <sup>2</sup>
Conductor cross section, flexible, with ferrule, with plastic sleeve	4 mm <sup>2</sup> ... 25 mm <sup>2</sup>
2 conductors with same cross section, solid	2.5 mm <sup>2</sup> ... 10 mm <sup>2</sup>
2 conductors with same cross section, flexible	4 mm <sup>2</sup> ... 10 mm <sup>2</sup>
2 conductors with same cross section, flexible, with ferrule without plastic sleeve	2.5 mm <sup>2</sup> ... 10 mm <sup>2</sup>
2 conductors with the same cross section, flexible, with TWIN ferrule with plastic sleeve	2.5 mm <sup>2</sup> ... 10 mm <sup>2</sup>
Internal cylindrical gage	B7
Stripping length	19 mm
Torque	4 Nm ... 4.5 Nm

### Connection capacity, internal

Connection method	Screw connection with tension sleeve
Connection direction of the conductor to plug-in direction	0 °
Conductor cross section solid	6 mm <sup>2</sup> ... 35 mm <sup>2</sup>
Conductor cross section flexible	10 mm <sup>2</sup> ... 25 mm <sup>2</sup>
Conductor cross section flexible, with ferrule without plastic sleeve	4 mm <sup>2</sup> ... 25 mm <sup>2</sup>
Conductor cross section, flexible, with ferrule, with plastic sleeve	4 mm <sup>2</sup> ... 25 mm <sup>2</sup>
2 conductors with same cross section, solid	2.5 mm <sup>2</sup> ... 10 mm <sup>2</sup>
2 conductors with same cross section, flexible	4 mm <sup>2</sup> ... 10 mm <sup>2</sup>
2 conductors with same cross section, flexible, with ferrule without plastic sleeve	2.5 mm <sup>2</sup> ... 10 mm <sup>2</sup>
2 conductors with the same cross section, flexible, with TWIN ferrule with plastic sleeve	2.5 mm <sup>2</sup> ... 10 mm <sup>2</sup>

# Panel feed-through terminal block - UWV 25/S - 3073458

## Technical data

### Connection capacity, internal

Internal cylindrical gage	B7
Stripping length	19 mm
Torque	4 Nm ... 4.5 Nm

### Material data - contact

Note	WEEE/RoHS-compliant, free of whiskers according to IEC 60068-2-82/ JEDEC JESD 201
Contact material	Cu alloy
Surface characteristics	tin-plated

### Material data - housing

Housing color	gray (7042)
Insulating material	PA
Insulating material group	I
CTI according to IEC 60112	600
Flammability rating according to UL 94	V0
Glow wire flammability index GWFI according to EN 60695-2-12	850
Glow wire ignition temperature GWIT according to EN 60695-2-13	775
Temperature for the ball pressure test according to EN 60695-10-2	125 °C

### Dimensions for the product

Caption	Schematische Abbildung - weitere Details siehe Produktfamilienzeichnung im Download Center
Width [ w ]	15.1 mm
Pitch	15.1 mm

### Dimensions for mounting cutout

Plate thickness	1 mm ... 6 mm
-----------------	---------------

### Packaging information

Type of packaging	packed in cardboard
Pieces per package	25
Denomination packing units	Pcs.

### Ambient conditions

Ambient temperature (storage/transport)	-40 °C ... 70 °C
Ambient temperature (assembly)	-5 °C ... 100 °C
Ambient temperature (operation)	-40 °C ... 100 °C (Depending on the current carrying capacity/derating curve)

### Termination and connection method

Test for conductor damage and slackening	IEC 60947-7-1:2009-04
--	-----------------------

# Panel feed-through terminal block - UWV 25/S - 3073458

## Technical data

### Termination and connection method

	Test passed
--	-------------

### Pull-out test

Pull-out test	IEC 60947-7-1:2009-04
Conductor cross section / conductor type / tensile force	6 mm <sup>2</sup> / solid / > 80 N
	10 mm <sup>2</sup> / flexible / > 90 N
	35 mm <sup>2</sup> / stranded / > 190 N
	25 mm <sup>2</sup> / flexible / > 135 N

### Mechanical tests according to standard

Test specification	IEC 60947-7-1 (following)
--------------------	---------------------------

### Electrical tests

Rated current	101 A
Conductor cross section	25 mm <sup>2</sup>

### Air clearances and creepage distances

Clearances and creepage distances	without spacer plate IEC 60947-7-1:2009-04
Application	without spacer plate
Specification	IEC 60947-7-1:2009-04
Minimum clearance - inhomogeneous field (III/3)	5.5 mm
Minimum creepage distance value (III/3)	8 mm

### Temperature-rise test

Specification	IEC 60947-7-1:2009-04
Requirement temperature-rise test	Increase in temperature ≤ 45 K

### Standards and Regulations

Connection in acc. with standard	UL
	IEC 60947-7-1
Flammability rating according to UL 94	V0
Safety note	<ul style="list-style-type: none"> <li>• Only electrically qualified personnel may install and operate the product. To recognize and prevent danger, the qualified personnel must be familiar with the basics of electrical engineering.</li> <li>• Observe the technical data provided here and refer to the documents listed under "Downloads". The download area contains important information, such as installation notes, technical drawings, and 3D data.</li> <li>• The cable entry funnel is not safe to touch. Never connect or disconnect the terminal when it is energized. Take appropriate steps to ensure touch protection.</li> </ul>

### Glow-wire test

Specification	IEC 60695-2-11:2000-10
---------------	------------------------

# Panel feed-through terminal block - UWV 25/S - 3073458

## Technical data

### Glow-wire test

Temperature	960 °C
Time of exposure	30 s

### Environmental Product Compliance

China RoHS	Environmentally friendly use period: unlimited = EFUP-e
	No hazardous substances above threshold values

## Drawings

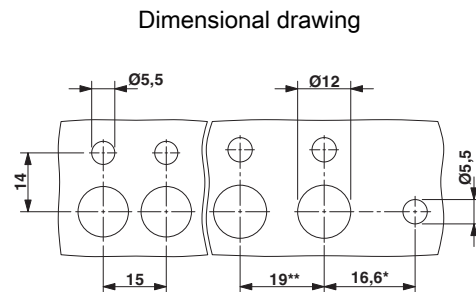
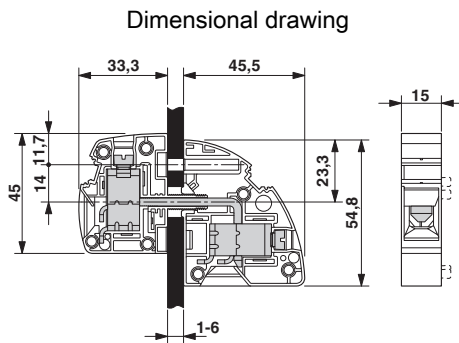

\* Only when using the UW...-F flange plate

\*\* Dimensions when using the DP-UW... spacer plate

## Classifications

### eCl@ss

eCl@ss 10.0.1	27141134
eCl@ss 11.0	27141134
eCl@ss 4.0	27141100
eCl@ss 4.1	27141100
eCl@ss 5.0	27141100
eCl@ss 5.1	27141100
eCl@ss 6.0	27141100
eCl@ss 7.0	27141134
eCl@ss 9.0	27141134

### ETIM

ETIM 2.0	EC001283
ETIM 3.0	EC001283
ETIM 4.0	EC001283
ETIM 6.0	EC001283

# Panel feed-through terminal block - UWV 25/S - 3073458

## Classifications

### ETIM

ETIM 7.0	EC001283
----------	----------

### UNSPSC

UNSPSC 6.01	30211811
UNSPSC 7.0901	39121410
UNSPSC 11	39121410
UNSPSC 12.01	39121410
UNSPSC 13.2	39121410
UNSPSC 18.0	39121410
UNSPSC 19.0	39121410
UNSPSC 20.0	39121410
UNSPSC 21.0	39121410

## Approvals

### Approvals

Approvals

EAC / cULus Recognized

Ex Approvals

### Approval details

EAC		B.01687
-----	---	---------

cULus Recognized		<a href="http://database.ul.com/cgi-bin/XYV/template/LISEXT/1FRAME/index.htm">http://database.ul.com/cgi-bin/XYV/template/LISEXT/1FRAME/index.htm</a>	E60425-20100423
	B	C	
Nominal voltage UN	600 V	600 V	
Nominal current IN	112.5 A	112.5 A	
mm <sup>2</sup> /AWG/kcmil	10-2	10-2	

## Panel feed-through terminal block - UWV 25/S - 3073458

### Accessories

#### Accessories

#### Crimping tool

##### Crimping pliers - CRIMPFOX 6 - 1212034



Crimping pliers, for ferrules without insulating collar according to DIN 46228 Part 1 and ferrules with insulating collar according to DIN 46228 Part 4, 0.25 mm<sup>2</sup> ... 6.0 mm<sup>2</sup>, lateral entry, trapezoidal crimp

---

##### Crimping pliers - CRIMPFOX 25R - 1212039



Crimping pliers, for ferrules without insulating collar according to DIN 46228 Part 1 and ferrules with insulating collar according to DIN 46228 Part 4, 10 mm<sup>2</sup> ... 25 mm<sup>2</sup>, lateral entry, WM crimp

---

##### Crimping pliers - CRIMPFOX 50R - 1212041



Crimping pliers, for ferrules without insulating collar according to DIN 46228 Part 1 and ferrules with insulating collar according to DIN 46228 Part 4, 35 mm<sup>2</sup> ... 50 mm<sup>2</sup>, lateral entry, WM crimp

---

### Flange

#### Flange cover - UWV 25-F - 3074622



Flange, number of positions: 0, color: gray

---

### Partition plate

## Panel feed-through terminal block - UWV 25/S - 3073458

### Accessories

Spacer plate - DP-UWV 25 - 3074431



Spacer plate, number of positions: 0, pitch: 0 mm, color: gray

---

### Screwdriver tools

Screwdriver - SZS 1,0X6,5 VDE - 1205079



Screwdriver, slot-headed, VDE insulated, size: 1.0 x 6.5 x 150 mm, 2-component grip, with non-slip grip

---

### Terminal marking

Zack marker strip - ZB 15:UNBEDRUCKT - 0811972



Zack marker strip, Strip, white, unlabeled, can be labeled with: PLOTMARK, CMS-P1-PLOTTER, mounting type: snap into tall marker groove, for terminal block width: 15.2 mm, lettering field size: 10.5 x 15.1 mm, Number of individual labels: 5

---

Zack Marker strip, flat - ZBF 15:UNBEDRUCKT - 0811202



Zack Marker strip, flat, Strip, white, unlabeled, can be labeled with: PLOTMARK, CMS-P1-PLOTTER, mounting type: snap into flat marker groove, for terminal block width: 15 mm, lettering field size: 15 x 5.2 mm, Number of individual labels: 5

---

Marker for terminal blocks - TMT 100 R - 0816605



Marker for terminal blocks, Roll, white, unlabeled, can be labeled with: THERMOMARK ROLL 2.0, THERMOMARK ROLL, THERMOMARK ROLL X1, THERMOMARK ROLLMASTER 300/600, THERMOMARK X1.2, THERMOMARK S1.1, unperforated, mounting type: snap into universal marker groove, snap into flat marker groove, for terminal block width: 100 mm, lettering field size: 6.35 x 101.5 mm, Number of individual labels: 1000

## Panel feed-through terminal block - UWV 25/S - 3073458

### Accessories

---

#### Marker for terminal blocks - TMT (EX9,5)R - 0828295



Marker for terminal blocks, Roll, white, unlabeled, can be labeled with: THERMOMARK ROLL 2.0, THERMOMARK ROLL, THERMOMARK ROLL X1, THERMOMARK ROLLMASTER 300/600, THERMOMARK X1.2, mounting type: snap into universal marker groove, snap into tall marker groove, for terminal block width: 50000 mm, lettering field size: 9.5 x 50000 mm, Number of individual labels: 1

---

---